

H4060



GoSmart IP indoor IP-220W 4MPx PTZ camera



Table of Contents

Safety instructions and warnings	2
Contents of the package	3
Technical Specifications	3
Description of the device	4
Installation and assembly	5
Controls and functions	10
Troubleshooting FAQ	11

Safety instructions and warnings



Read the instructions before using the device.



Observe the safety instructions in this manual.



Do not dispose of electrical appliances as unsorted municipal waste, use sorted waste collection points. Contact your local authority for up-to-date information on collection points. If electrical appliances are disposed of in landfill sites, hazardous substances can leach into groundwater and enter the food chain and harm your health.

Do not use water or chemicals to clean dirt from the outside of the device. Always use a dry cloth to prevent mechanical damage and electric shock.

Do not connect the power cord to the power outlet with wet or damp hands, as there is a risk of electric shock. Do not disassemble, repair or modify the equipment yourself. Doing so may result in fire, electric shock or permanent damage.

EMOS spol. s r.o. declares that the product H4060 complies with the essential requirements and other relevant provisions of the directives. The equipment can be operated freely in the EU.

The Declaration of Conformity can be found on the website <http://www.emos.eu/download>.

The equipment can be operated on the basis of general authorisation No. VO-R/10/07.2021-8 as amended.



Package contents
Camera unit
Power adapter
USB cable
Camera mount
Screw set
Manual



Technical specifications

Power supply: DC 5 V/1 A
Dimensions: 82 × 82 × 107 mm
Resolution: 2 560 × 1 440
Sensor: 1/3.0" 4Megapixel CMOS
Motion detection length: 10 m
Motion detection angle: 100°
Storage: SD card (max. 256 GB, FAT32), Cloud storage
Degree of protection: IP20
APP: EMOS GoSmart for Android and iOS
Connectivity: 2.4 GHz Wi-Fi (IEEE802.11b/g/n),
5 GHz Wi-Fi (IEEE802.11b/g/n/ax)

Description of the device



- 1 - Lens
- 2 - Status light
 - The LED is red: the camera is reporting an error.
 - The LED flashes red: the camera is preparing to connect to a Wi-Fi network.
 - The LED flashes red quickly: you are now connecting to a Wi-Fi network.
 - The LED is blue: the camera is working properly.
- 3 - Microphone
- 4 - IR LED
- 5 - Speaker
- 6 - Charging port
- 7 - Place for mounting the holder
- 8 - SD card slot
- 9 - Reset button
 - Press the RESET button for 5 seconds to reset the instrument to factory settings.



Connecting

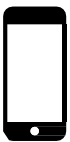

The camera can connect to both 2.4GHz and 5GHz Wi-Fi frequencies.

Installation and assembly

Installation on a flat surface

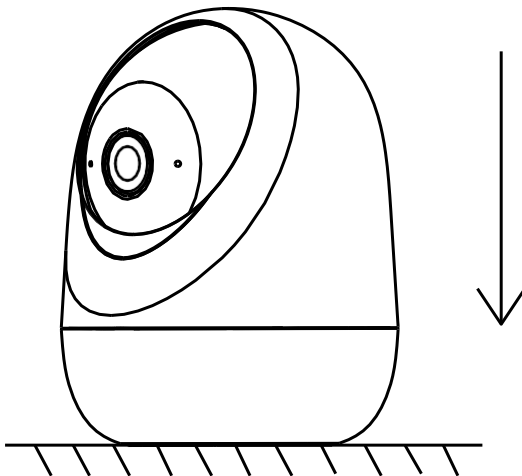

Place the camera in the desired location, and connect the power supply.

Installation in the holder

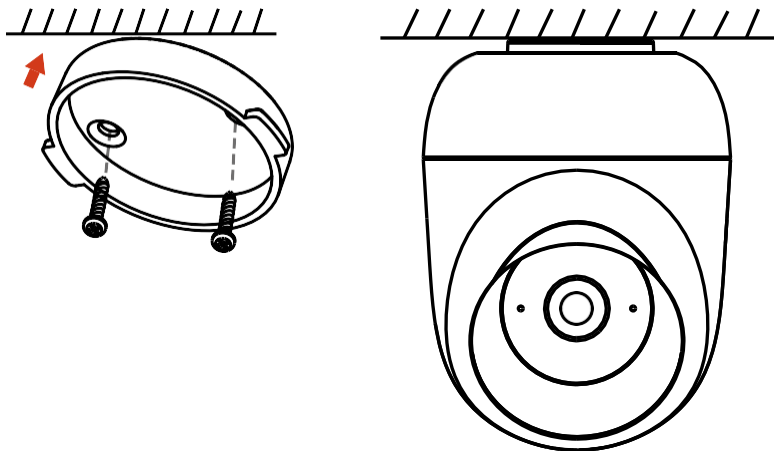

Place the bracket in the desired location, then screw it in place with the screws.
Place the camera on the bracket and fix it by turning it.

Pairing with an app

Installing the EMOS GoSmart app



The app is available for Android and iOS via Google Play and the App Store. To download the app, please scan the relevant QR code.

EMOS GoSmart mobile app

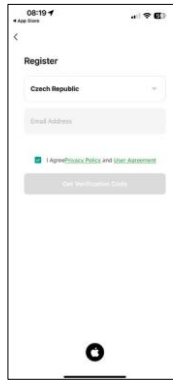
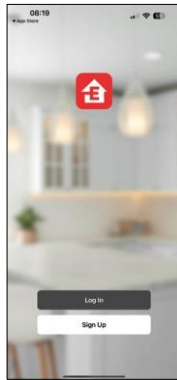
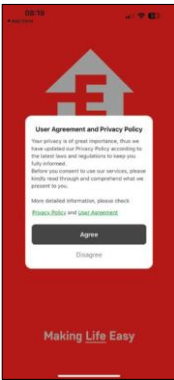

Open the EMOS GoSmart app and confirm the privacy policy and click "I agree". Select "Register". Enter the name of a valid email address and choose a password. Confirm your consent to the privacy policy. Select "Register".

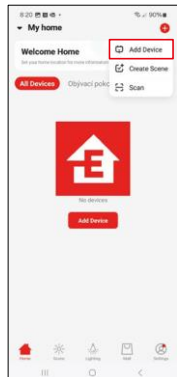

Select "Add Device".
Select the GoSmart product category and select the Camera IP-220W device.

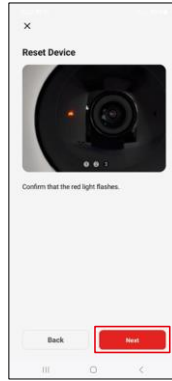
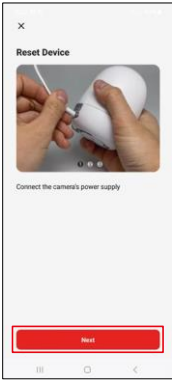

Connect power to the camera.

Reset the device using the RESET button on the underside of the camera swivel. Make sure the red LED is flashing.

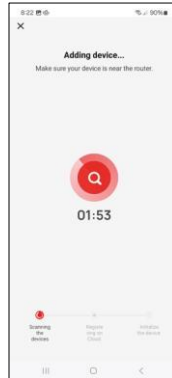
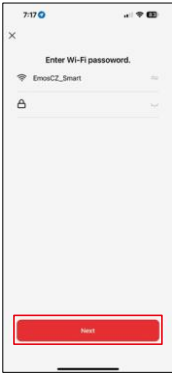

Enter the name and password of your Wi-Fi network. This information remains encrypted and is used to allow the camera to communicate with your mobile device remotely.

A QR code will appear on the display of your mobile device. Place the QR code in front of the camera lens.





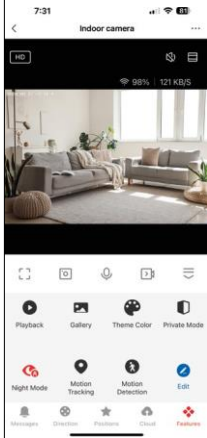

















Confirm that you have heard the beep for a successful pairing. The device will be automatically found.

The device is located. Confirm with the "Done" button.



Icons and indicator lights

Description of controls in the application

	Advanced settings (described in more detail in the following section)
	Video quality switching (HD/SD)
	Signal quality and speed
	Mute
	Zoom in
	Full screen mode
	Take pictures using the app and save them to your mobile album
	Speak
	Take a video using the app and save it to your mobile album
	Expand menu
	To play a video stored on an SD card
	See videos and photos taken by the app
	Light mode / dark mode
	Private mode - the camera stops shooting and the whole lens turns inwards
	Night modesettings. We recommend setting to AUTO.
	Motion tracking - the camera automatically follows the moving object
	Motion detection - the camera will alert you if it detects any movement
	Edit icons + add control of another device
	Position settings (described in more detail in the following section)
	Manual camera movement
	Manage and purchase cloud storage
	Display of messages (Motion detection...)

Description of extension settings

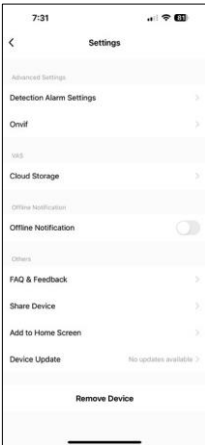
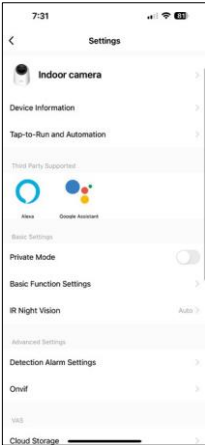

- Device information - Basic information about the device and its owner
- Tap-to-Run and Automation - View scenes and automations assigned to the device. Creation of scenes is possible directly in the main menu of the application in the section "Scenes". For example, the H4060 could be automated to set a lower motion detection sensitivity between 6pm and 7am.
- Basic Function Settings - Option to enable/disable basic device functions such as automatic screen rotation or watermarking with time and date display. Another important setting is the ability to select one-way or two-way communication.
- IR Night Vision - Night mode setting.
- Detection Alarm Settings - Alarm settings.
- Activity Area - Set the zone in which the camera captures motion. For example, if your camera is sensing a road you don't want the camera to alert you to every car that passes by, so this feature allows you to select the area that will be sensed by the motion sensor.
- Human Body Filtering - Human Body Contour Recognition. When this feature is enabled, the device should not alert you to every movement, but only when it recognizes the human body.
- Onvif - Basic Onvif settings for connecting the camera to external viewers such as NVR systems.
- Cloud Storage - Cloud storage settings. Cloud is not included with the camera, but can be purchased additionally through the app.
- Offline Notification - To avoid constant reminders, a notification will be sent if the device remains offline for more than 30 minutes.
- FAQ & Feedback - View the most common questions along with their solutions plus the ability to send a question/suggestion/feedback directly to us
- Share Device - Share device management to another user
- Add to Home Screen - Add an icon to your phone's home screen. With this step, you don't have to open your device through the app every time, but just click directly on this added icon and it will take you straight to the camera view
- Device update - Device update. Option to enable automatic updates
- Remove Device - Remove and unpair a device. An important step if you wish to change the owner of the device. After adding the device to the app, the device is paired and cannot be added under another account.

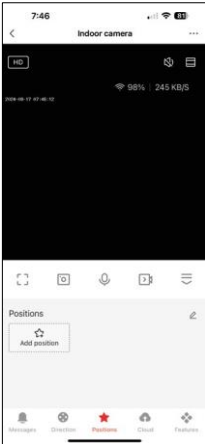

Controls and functions

Setting the positions

This feature allows you to set predefined positions for the camera, so you don't have to manually rotate the camera to the desired location.

1. Turn the camera to the desired angle using the directional buttons.
2. Click on the "Positions" tab
3. Save the angle by pressing the "Add position" button and name the position according to your preference.

By setting multiple positions, you can quickly and easily change the view by pressing a saved icon.

Recording to SD card

One of the basic functions of the home security system is the SD card recording function.

The camera supports SD cards with a maximum size of 256 GB in FAT32 format. When the SD card is full, the recordings are automatically overwritten.

Instructions on how to enable the SD card function:

1. Insert the Micro SD card into the appropriate slot.
2. Open the advanced device settings and select "Storage settings".
3. Format the SD card. NOTE: Do not turn off the application or interrupt the process when formatting the SD card.
4. Switch on the PIR sensor and set the required sensitivity. In the settings there is an option to turn on/off human body recognition to prevent alarms when the camera detects, for example, the movement of an animal or a tree. Using

You can also designate an "Activity Area" where you want the camera to detect motion (for example, you don't want the camera to alert you to every car that drives down the road that the camera can see).



5. When the camera detects motion, it will also record a few seconds of footage, which can be found in the icon: 

Troubleshooting FAQ

I can't get the devices to pair. What can I do?

- Make sure you have a strong enough signal
- Allow the app all permissions in the settings
- Make sure you are using the latest version of the mobile operating system and the latest version of the app

They can hear me outside, but I can't hear the sound outside / I can hear the sound outside, but they can't hear me.

- Make sure you have granted all permissions to the app, especially for the microphone.
- One-way communication can also be a problem. If you see this icon at the bottom: , it means that the device is set to one-way communication.
- To fix this, go to the "Basic Function Settings" menu and set "Talk mode" to "Two-way talk". This menu can be found in the extension settings (see Chapter "Description of extension settings").
- The correct icon for two-way communication looks like this: 

I'm not getting notifications, why?

- Allow the app all permissions in the settings
- Turn on notifications in the app settings (Settings -> App notifications)

What SD card can I use?

- SD card with a maximum storage capacity of 256 GB and a minimum speed class of CLASS 10 in FAT32 format.

When the SD card memory is full, are the oldest records automatically overwritten or does the user have to manually delete them?

- Yes, the records are overwritten automatically.

Who all can use the device?

- The device must always have an admin (owner)
- Admin can share the device with the rest of the household and assign rights to them

